

Product name	Lat Pulldown	Model No.	AN04
--------------	--------------	-----------	------

Picture



Technical  
description  
n

- Main frame: it is welded with 60 \* 120 \* t3mm positive elliptical pipe diameter, with stable appearance and atmospheric shape.
- Movement track: the smooth movement track is more consistent with the principles of biomechanics and ergonomics.
- Guard board: the whole front guard board of the small door is made of acrylic plastic, and the back guard board is made of Q235 national standard coldrolled sheet.
- Cushion: excellent 3D polyurethane molding process; the surface is made of super fiber leather, waterproof and wearresistant; the color can be matched at will.
- Handle: PP soft rubber material, more comfortable to grip.
- Wire wheel: it is made of high quality PA material by injection molding, with national standard high quality bearing, quiet, smooth and fatigue resistant.
- Steel cable: high quality wearresistant special steel wire rope, 6mm in diameter, wrapped with PU wearresistant layer, 7 \* 19 high quality steel wire.

Lat Pulldow Size: L1250 W860 H2330mm N.W: 335kgs Training position: dorsi latissimus triangle muscle group			
Product name	Pectoral Machine	Model No.	AN05
Picture			
			
Technical description	<ul style="list-style-type: none"> <li>■ Main frame: it is welded with 60 * 120 * t3mm positive elliptical pipe diameter, with stable appearance and atmospheric shape.</li> <li>■ Trajectory: the smooth trajectory is more in line with the principles of biomechanics and ergonomics.</li> <li>■ Guard board: the whole front guard board of the small door is made of acrylic plastic, and the back guard board is made of Q235 national standard coldrolled sheet</li> <li>■ Cushion: excellent 3D polyurethane molding process; the surface is made of super fiber leather, waterproof and wearresistant; the color can be matched at will.</li> <li>■ Handle: PVC soft rubber material, more comfortable grip.</li> <li>■ Wire wheel: it is made of high quality PA material and injected with national standard high quality bearing, quiet, smooth and fatigue resistant.</li> <li>■ Steel cable: high quality wearresistant special steel wire rope, 6mm in diameter, wrapped with PU wearresistant layer, 7 * 19 high quality steel wire.</li> </ul>		
	Pectoral Machine Size: L1230 W1420 H1500mm N.W.:275kgs Training site: pectoralis major and pectoralis major		

Product name	Long Pully	Model No.	AN06
--------------	------------	-----------	------

Picture



<p>Tech nical desc ription</p>	<ul style="list-style-type: none"> <li>■ Main frame: it is welded with 60 * 120 * t3mm positive elliptical pipe diameter, with stable appearance and atmospheric shape.</li> <li>■ Trajectory: the smooth trajectory is more in line with the principles of biomechanics and ergonomics. Guard board: the whole front guard board of the small door is made of acrylic plastic, and the back guard board is made of Q235 national standard coldrolled sheet Cushion: excellent 3D polyurethane molding process; the surface is made of super fiber leather, waterproof and wearresistant; the color can be matched at will.</li> <li>■ Handle: PP material, more comfortable grip.</li> <li>■ Wire wheel: it is made of high quality PA material and injected with national standard high quality bearing, quiet, smooth and fatigue resistant.</li> <li>■ Steel cable: high quality wearresistant special steel wire rope, 6mm in diameter, wrapped with PU wearresistant layer, 7 * 19 high quality steel wire.</li> </ul> <p>Long Press Size: L1780 W1340 H1840mm N.W.:360kgs Training site: biceps brachii, latissimus dorsi, trapezius dorsalis</p>
--	--

Product name	Adductor/Inner Thigh	Model No.	AN09
--------------	----------------------	-----------	------

Picture



<p>Technical description</p>	<ul style="list-style-type: none"> <li>■ Main frame: it is welded with 60 * 120 * t3mm positive elliptical pipe diameter, with stable appearance and atmospheric shape. Trajectory: the smooth trajectory is more in line with the principles of biomechanics and ergonomics.</li> <li>■ Guard board: the whole front guard board of the small door is made of acrylic plastic, and the back guard board is made of Q235 national standard coldrolled sheet. Cushion: excellent 3D polyurethane molding process; the surface is made of super fiber leather, waterproof and wearresistant; the color can be matched at will.</li> <li>■ Handle: PVC rubber material, more comfortable to grip。</li> <li>■ Wire wheel: it is made of high quality PA material and injected with national standard high quality bearing, quiet, smooth and fatigue resistant.</li> <li>■ Steel cable: high quality wearresistant special steel wire rope, 6mm in diameter, wrapped with PU wearresistant layer, 7 * 19 high quality steel wire.</li> </ul> <p>Adductor/Inner Thigh Size: L1430 W930 H1500mm N.W.:280kgs Training position: gluteus maximus, lateral thigh muscle</p>
------------------------------	--

Product name	Abductor/Outer Thigh	Model No.	AN10
--------------	----------------------	-----------	------

Picture





Technical description

- Main frame: it is welded with 60 \* 120 \* t3mm positive elliptical pipe diameter, with stable appearance and atmospheric shape.
- Trajectory: the smooth trajectory is more in line with the principles of biomechanics and ergonomics. Guard board: the whole front guard board of the small door is made of acrylic plastic, and the back guard board is made of Q235 national standard coldrolled sheet. Cushion: excellent 3D polyurethane molding process; the surface is made of super fiber leather, waterproof and wear-resistant; the color can be matched at will.
- Handle: PVC soft rubber material, more comfortable grip.
- Wire wheel: it is made of high quality PA material and injected with national standard high quality bearing, quiet, smooth and fatigue resistant.
- Steel cable: high quality wear-resistant special steel wire rope, 6mm in diameter, wrapped with PU wear-resistant layer, 7 \* 19 high quality steel wire.

Abductor/Outer Thigh      Size: L1330      W850      H1500mm  
 N.W.:280kgs Training position: lateral thigh muscle

Product name	Arm Extension	Model No.	AN15
Picture			
			
Technical description	<ul style="list-style-type: none"> <li>■ Main frame: it is welded with 60 * 120 * t3mm positive elliptical pipe diameter, with stable appearance and atmospheric shape.</li> <li>■ Trajectory: the smooth trajectory is more in line with the principles of biomechanics and ergonomics. Guard board: the whole front guard board of the small door is made of acrylic plastic, and the back guard board is made of Q235 national standard coldrolled sheet Cushion: excellent 3D polyurethane molding process; the surface is made of super fiber leather, waterproof and wearresistant; the color can be matched at will.</li> <li>■ Handle: PVC material, more comfortable to hold.</li> <li>■ Wire wheel: it is made of high quality PA material and injected with national standard high quality bearing, quiet, smooth and fatigue resistant.</li> <li>■ Steel cable: high quality wearresistant special steel wire rope, 6mm in diameter, wrapped with PU wearresistant layer, 7 * 19 high quality steel wire.</li> </ul> <p>Arm Extension Size: L1020 W1440 H1500mm N.W.:260kgs                  Training position: triceps pectoralis major, anterior serratus deltoid</p>		

Product name	Leg Press	Model No.	AN16
Picture			
			
Technical description	<ul style="list-style-type: none"> <li>■ The product appearance design absorbs the advanced design concept of foreign countries and improves it on the original basis to better meet the fitness needs of Chinese people.</li> <li>■ Trajectory: the smooth trajectory is more in line with the principles of biomechanics and ergonomics. Guard board: the whole front guard board of the small door is made of acrylic plastic, and the back guard board is made of Q235 national standard coldrolled sheet Cushion: excellent 3D polyurethane molding process; the surface is made of super fiber leather, waterproof and wearresistant; the color can be matched at will.</li> <li>■ Handle: PVC soft rubber material, more comfortable grip.</li> <li>■ Wire wheel: it is made of high quality PA material and injected with national standard high quality bearing, quiet, smooth and fatigue resistant.</li> <li>■ Steel cable: high quality wearresistant special steel wire rope, 6mm in diameter, wrapped with PU wearresistant layer, 7 * 19 high quality steel wire.</li> </ul> <p>Leg Press                  Size: L1970 W1110 H1830mm N.W.:445kgs                  Training position: thigh muscle group</p>		

Product name	Multi Hip	Model No.	AN18
Picture			
			
<p>Technical   description</p>	<ul style="list-style-type: none"> <li>■ Main frame: it is welded with 60 * 120 * t3mm positive elliptical pipe diameter, with stable appearance and atmospheric shape.</li> <li>■ Trajectory: the smooth trajectory is more in line with the principles of biomechanics and ergonomics.</li> </ul> <p>Guard board: the overall rear guard board of the small door is made of Q235 national standard coldrolled sheet.</p> <p>Handle: PP soft rubber material, more comfortable to grip.</p> <ul style="list-style-type: none"> <li>■ Wire wheel: it is made of high quality PA material and injected with national standard high quality bearing, quiet, smooth and fatigue resistant.</li> <li>■ Steel cable: high quality wearresistant special steel wire rope, 6mm in diameter, wrapped with PU wearresistant layer, 7 * 19 high quality steel wire.</li> </ul> <p>Multi Hip Size: L1220 W1110 H1500mm N.W.:290kgs Training position: gluteus maximus</p>		





Product name	Back Extension	Model No.	AN19
Picture			
			
<p>Technical description</p>	<ul style="list-style-type: none"> <li>■ Main frame: it is welded with 60 * 120 * t3mm positive elliptical pipe diameter, with stable appearance and atmospheric shape.</li> <li>■ Trajectory: the smooth trajectory is more in line with the principles of biomechanics and ergonomics. Guard board: the whole front guard board of the small door is made of acrylic plastic, and the back guard board is made of Q235 national standard coldrolled sheet Cushion: excellent 3D polyurethane molding process; the surface is made of super fiber leather, waterproof and wearresistant; the color can be matched at will.</li> <li>■ Wire wheel: it is made of high quality PA material and injected with national standard high quality bearing, quiet, smooth and fatigue resistant.</li> <li>■ Steel cable: high quality wearresistant special steel wire rope, 6mm in diameter, wrapped with PU wearresistant layer, 7 * 19 high quality steel wire.</li> </ul> <p>Back Extension Size: L1080 W1260 H1500mm N.W.:255kgs                  Training position: back muscles</p>		

Product name	Seated Chest Press	Model No.	AN20
Picture			
			
Technical description	<ul style="list-style-type: none"> <li>■ Main frame: it is welded with 60 * 120 * t3mm positive elliptical pipe diameter, with stable appearance and atmospheric shape.</li> <li>■ Trajectory: the smooth trajectory is more in line with the principles of biomechanics and ergonomics. Guard board: the whole front guard board of the small door is made of acrylic plastic, and the back guard board is made of Q235 national standard coldrolled sheet Cushion: excellent 3D polyurethane molding process; the surface is made of super fiber leather, waterproof and wearresistant; the color can be matched at will.</li> <li>■ Handle: PVC soft rubber material, more comfortable grip.</li> <li>■ Wire wheel: it is made of high quality PA material and injected with national standard high quality bearing, quiet, smooth and fatigue resistant.</li> <li>■ Steel cable: high quality wearresistant special steel wire rope, 6mm in diameter, wrapped with PU wearresistant layer, 7 * 19 high quality steel wire.</li> </ul> <p>Seated Chest Press Size: L1400 W1380 H1660mm N.W.:290kgs                  Training site: pectoral muscle, shoulder deltoid muscle and brachial triceps muscle</p>		

Product name	Vertical Traction	Model No.	AN21
Picture			
			
<p>Technical description</p>	<ul style="list-style-type: none"> <li>■ Main frame: it is welded with 60 * 120 * t3mm positive elliptical pipe diameter, with stable appearance and atmospheric shape.</li> <li>■ Trajectory: the smooth trajectory is more in line with the principles of biomechanics and ergonomics. Guard board: the whole front guard board of the small door is made of acrylic plastic, and the back guard board is made of Q235 national standard coldrolled sheet Cushion: excellent 3D polyurethane molding process; the surface is made of super fiber leather, waterproof and wearresistant; the color can be matched at will.</li> <li>■ Handle: PVC soft rubber material, more comfortable grip.</li> <li>■ Wire wheel: it is made of high quality PA material and injected with national standard high quality bearing, quiet, smooth and fatigue resistant.</li> <li>■ Steel cable: high quality wearresistant special steel wire rope, 6mm in diameter, wrapped with PU wearresistant layer, 7 * 19 high quality steel wire.</li> </ul> <p>Vertical Traction Size: L1360 W1290 H1810mm N.W.:300kgs                  Training position: dorsi latissimus triangle muscle group</p>		

Product name	Total Abdominal	Model No.	AN22
Picture			
			
<p>Technical description</p>	<ul style="list-style-type: none"> <li>■ Main frame: it is welded with 60 * 120 * t3mm positive elliptical pipe diameter, with stable appearance and atmospheric shape.</li> <li>■ Trajectory: the smooth trajectory is more in line with the principles of biomechanics and ergonomics. Guard board: the whole front guard board of the small door is made of acrylic plastic, and the back guard board is made of Q235 national standard coldrolled sheet Cushion: excellent 3D polyurethane molding process; the surface is made of super fiber leather, waterproof and wearresistant; the color can be matched at will.</li> </ul> <p>Handle: polyurethane foam material, more comfortable grip.</p> <ul style="list-style-type: none"> <li>■ Wire wheel: it is made of high quality PA material and injected with national standard high quality bearing, quiet, smooth and fatigue resistant.</li> <li>■ Steel cable: high quality wearresistant special steel wire rope, 6mm in diameter, wrapped with PU wearresistant layer, 7 * 19 high quality steel wire.</li> </ul> <p>Total Abdominal    Size: L970 W1300 H1500mm    N.W.:285kgs                      Training site: abdominal muscle group</p>		

Product name	Assisted Chin Up/Dip	Model No.	AN23
Picture			
			
Technical description	<ul style="list-style-type: none"> <li>■ Main frame: it is welded with 60 * 120 * t3mm positive elliptical pipe diameter, with stable appearance and atmospheric shape.</li> <li>■ Trajectory: the smooth trajectory is more in line with the principles of biomechanics and ergonomics. Guard board: the whole front guard board of the small door is made of acrylic plastic, and the back guard board is made of Q235 national standard coldrolled sheet. Handle: PP soft rubber material, more comfortable to grip.</li> <li>■ Wire wheel: it is made of high quality PA material and injected with national standard high quality bearing, quiet, smooth and fatigue resistant.</li> <li>■ Steel cable: high quality wearresistant special steel wire rope, 6mm in diameter, wrapped with PU wearresistant layer, 7 * 19 high quality steel wire.</li> </ul> <p>Assisted Chin Up/Dip Size: L1750 W1440 H2800mm N.W.:350kgs                  Training site: triceps brachii deltoid pectoralis major anterior serratus latissimus dorsi</p>		

Product name	Seated Leg Curl	Model No.	AN24
Picture			
			
Techni cal descri ption	<ul style="list-style-type: none"> <li>■ Main frame: it is welded with 60 * 120 * t3mm positive elliptical pipe diameter, with stable appearance and atmospheric shape.</li> <li>■ Trajectory: the smooth trajectory is more in line with the principles of biomechanics and ergonomics. Guard board: the whole front guard board of the small door is made of acrylic plastic, and the back guard board is made of Q235 national standard coldrolled sheet Cushion: excellent 3D polyurethane molding process; the surface is made of super fiber leather, waterproof and wearresistant; the color can be matched at will.</li> <li>■ Wire wheel: it is made of high quality PA material and injected with national standard high quality bearing, quiet, smooth and fatigue resistant.</li> <li>■ Steel cable: high quality wearresistant special steel wire rope, 6mm in diameter, wrapped with PU wearresistant layer, 7 * 19 high quality steel wire.</li> </ul>		
Seated Leg Curl    Size: L1080    W1280    H1500mm    N.W.:255kgs Training position: quadriceps femoris			

Product name	Arm Curl	Model No.	AN25
Picture			
			
Techni cal descri ption	<ul style="list-style-type: none"> <li>■ Main frame: it is welded with 60 * 120 * t3mm positive elliptical pipe diameter, with stable appearance and atmospheric shape.</li> <li>■ Trajectory: the smooth trajectory is more in line with the principles of biomechanics and ergonomics. Guard board: the whole front guard board of the small door is made of acrylic plastic, and the back guard board is made of Q235 national standard coldrolled sheet Cushion: excellent 3D polyurethane molding process; the surface is made of super fiber leather, waterproof and wearresistant; the color can be matched at will.</li> <li>■ Handle: PVC soft rubber material, more comfortable grip.</li> <li>■ Wire wheel: it is made of high quality PA material and injected with national standard high quality bearing, quiet, smooth and fatigue resistant.</li> <li>■ Steel cable: high quality wearresistant special steel wire rope, 6mm in diameter, wrapped with PU wearresistant layer, 7 * 19 high quality steel wire.</li> </ul> <p>Arm Curl Size: L990 W1430 H1500mm N.W.:260kgs Training site: biceps based arm muscle group</p>		

Product name	Shoulder Press	Model No.	AN26
Picture			
			
Technic al descrip tion	<ul style="list-style-type: none"> <li>■ Main frame: it is welded with 60 * 120 * t3mm positive elliptical pipe diameter, with stable appearance and atmospheric shape.</li> <li>■ Trajectory: the smooth trajectory is more in line with the principles of biomechanics and ergonomics. Guard board: the whole front guard board of the small door is made of acrylic plastic, and the back guard board is made of Q235 national standard coldrolled sheet Cushion: excellent 3D polyurethane molding process; the surface is made of super fiber leather, waterproof and wearresistant; the color can be matched at will.</li> <li>■ Handle: PVC soft rubber material, more comfortable grip.</li> <li>■ Wire wheel: it is made of high quality PA material and injected with national standard high quality bearing, quiet, smooth and fatigue resistant.</li> <li>■ Steel cable: high quality wearresistant special steel wire rope, 6mm in diameter, wrapped with PU wearresistant layer, 7 * 19 high quality steel wire.</li> </ul> <p>Shoulder Press Size: L1300 W1400 H1500mm N.W.:270kgs Training position: trapezius of levator scapulae</p>		



Product name	Seated Leg Extension	Model No.	AN27
Picture			
			
Techni cal descri ption	<ul style="list-style-type: none"> <li>■ Main frame: it is welded with 60 * 120 * t3mm positive elliptical pipe diameter, with stable appearance and atmospheric shape.</li> <li>■ Trajectory: the smooth trajectory is more in line with the principles of biomechanics and ergonomics. Guard board: the whole front guard board of the small door is made of acrylic plastic, and the back guard board is made of Q235 national standard coldrolled sheet Cushion: excellent 3D polyurethane molding process; the surface is made of super fiber leather, waterproof and wearresistant; the color can be matched at will.</li> <li>■ Wire wheel: it is made of high quality PA material and injected with national standard high quality bearing, quiet, smooth and fatigue resistant.</li> <li>■ Steel cable: high quality wearresistant special steel wire rope, 6mm in diameter, wrapped with PU wearresistant layer, 7 * 19 high quality steel wire.</li> </ul> <p>Seated Leg Extension    Size: L1270    W1110    H1500mm    N.W.:255kgs                  Training position: quadriceps femoris</p>		

Product name	Abdominal Crunch	Model No.	AN30
Picture			
			
<p>Techni cal descri ption</p>	<ul style="list-style-type: none"> <li>■ Main frame: it is welded with 60 * 120 * t3mm positive elliptical pipe diameter, with stable appearance and atmospheric shape.</li> <li>■ Trajectory: the smooth trajectory is more in line with the principles of biomechanics and ergonomics. Guard board: the whole front guard board of the small door is made of acrylic plastic, and the back guard board is made of Q235 national standard coldrolled sheet Cushion: excellent 3D polyurethane molding process; the surface is made of super fiber leather, waterproof and wearresistant; the color can be matched at will.</li> <li>■ Handle: it is made of polyurethane foam soft rubber, which is more comfortable to grip.</li> <li>■ Wire wheel: it is made of high quality PA material and injected with national standard high quality bearing, quiet, smooth and fatigue resistant.</li> <li>■ Steel cable: high quality wearresistant special steel wire rope, 6mm in diameter, wrapped with PU wearresistant layer, 7 * 19 high quality steel wire.</li> </ul> <p><b>Abdominal Crunch</b>  <b>Size: L1040 W1320 H1500mm N.W.:255kgs</b>  <b>Training site: abdominal muscle group</b></p>		

Product name	Pull Down	Model No.	AN32
Picture			
			
Techni cal descri ption	<ul style="list-style-type: none"> <li>■ Main frame: it is welded with 60 * 120 * t3mm positive elliptical pipe diameter, with stable appearance and atmospheric shape.</li> <li>■ Trajectory: the smooth trajectory is more in line with the principles of biomechanics and ergonomics. Guard board: the whole front guard board of the small door is made of acrylic plastic, and the back guard board is made of Q235 national standard coldrolled sheet Cushion: excellent 3D polyurethane molding process; the surface is made of super fiber leather, waterproof and wearresistant; the color can be matched at will.</li> <li>■ Handle: PVC soft rubber material, more comfortable grip.</li> <li>■ Wire wheel: it is made of high quality PA material and injected with national standard high quality bearing, quiet, smooth and fatigue resistant.</li> <li>■ Steel cable: high quality wearresistant special steel wire rope, 6mm in diameter, wrapped with PU wearresistant layer, 7 * 19 high quality steel wire.</li> </ul> <p>Pull Down Size: L1280 W940 H1890mm N.W.:300kgs Training position: dorsi latissimus triangle muscle group</p>		

Product name	Low Row	Model No.	AN33
--------------	---------	-----------	------

Picture





Technical description

- Main frame: it is welded with 60 \* 120 \* t3mm positive elliptical pipe diameter, with stable appearance and atmospheric shape.
- Trajectory: the smooth trajectory is more in line with the principles of biomechanics and ergonomics. Guard board: the whole front guard board of the small door is made of acrylic plastic, and the back guard board is made of Q235 national standard coldrolled sheet. Cushion: excellent 3D polyurethane molding process; the surface is made of super fiber leather, waterproof and wear-resistant; the color can be matched at will.
- Handle: PVC soft rubber material, more comfortable grip.
- Wire wheel: it is made of high quality PA material and injected with national standard high quality bearing, quiet, smooth and fatigue resistant.
- Steel cable: high quality wear-resistant special steel wire rope, 6mm in diameter, wrapped with PU wear-resistant layer, 7 \* 19 high quality steel wire.

Low Row Size: L1050 W1180 H1500mm N.W.:255kgs

Training site: latissimus dorsi triangle muscle group training site: latissimus dorsi greater round muscle posterior deltoid muscle biceps brachii trapezius muscle

Product name	坐式肩部训练器	Model No.	AN34
Picture			
			
Technical description	<ul style="list-style-type: none"> <li>■ Main frame: it is welded with 60 * 120 * t3mm positive elliptical pipe diameter, with stable appearance and atmospheric shape.</li> <li>■ Trajectory: the smooth trajectory is more in line with the principles of biomechanics and ergonomics. Guard board: the whole front guard board of the small door is made of acrylic plastic, and the back guard board is made of Q235 national standard coldrolled sheet Cushion: excellent 3D polyurethane molding process; the surface is made of super fiber leather, waterproof and wearresistant; the color can be matched at will.</li> <li>■ Handle: PVC soft rubber material, more comfortable grip.</li> <li>■ Wire wheel: it is made of high quality PA material and injected with national standard high quality bearing, quiet, smooth and fatigue resistant.</li> <li>■ Steel cable: high quality wearresistant special steel wire rope, 6mm in diameter, wrapped with PU wearresistant layer, 7 * 19 high quality steel wire.</li> </ul> <p>Delt Machine Size: L1300 W1040 H1500mm N.W.:280kgs Training position: trapezius of levator scapulae</p>		

Product name	Rotary Torso	Model No.	AN35
Picture			
			
Technical description	<ul style="list-style-type: none"> <li>■ Main frame: it is welded with 60 * 120 * t3mm positive elliptical pipe diameter, with stable appearance and atmospheric shape.</li> <li>■ Trajectory: the smooth trajectory is more in line with the principles of biomechanics and ergonomics. Guard board: the whole front guard board of the small door is made of acrylic plastic, and the back guard board is made of Q235 national standard coldrolled sheet Cushion: excellent 3D polyurethane molding process; the surface is made of super fiber leather, waterproof and wearresistant; the color can be matched at will.</li> <li>■ Handle: with polyurethane foam technology, it is more comfortable to grasp.</li> <li>■ Wire wheel: it is made of high quality PA material and injected with national standard high quality bearing, quiet, smooth and fatigue resistant.</li> <li>■ Steel cable: high quality wearresistant special steel wire rope, 6mm in diameter, wrapped with PU wearresistant layer, 7 * 19 high quality steel wire.</li> </ul> <p>Rotary Torso Size: L1180 W1080 H1500mm N.W.:270kgs                  Training site: lumbar and abdominal muscles</p>		

Product name	Glute Isolator	Model No.	AN36
Picture			
			
Techni cal descri ption	<ul style="list-style-type: none"> <li>■ Main frame: it is welded with 60 * 120 * t3mm positive elliptical pipe diameter, with stable appearance and atmospheric shape.</li> <li>■ Trajectory: the smooth trajectory is more in line with the principles of biomechanics and ergonomics. Guard board: the whole front guard board of the small door is made of acrylic plastic, and the back guard board is made of Q235 national standard coldrolled sheet. Cushion: excellent 3D polyurethane molding process; the surface is made of super fiber leather, waterproof and wear-resistant; the color can be matched at will.</li> <li>■ Handle: PP soft rubber material, more comfortable to grip.</li> <li>■ Wire wheel: it is made of high quality PA material and injected with national standard high quality bearing, quiet, smooth and fatigue resistant.</li> <li>■ Steel cable: high quality wear-resistant special steel wire rope, 6mm in diameter, wrapped with PU wear-resistant layer, 7 * 19 high quality steel wire.</li> </ul> <p style="margin-top: 20px;">Glute Isolator    Size: L1240    W1330    H1840mm    N.W.:290kgs                  Training site: abductor adductor group of thigh, posterior group of thigh</p>		

Product name	Prone Leg Curl	Model No.	AN37
--------------	----------------	-----------	------

Picture



Technical description

- Main frame: it is welded with 60 \* 120 \* t3mm positive elliptical pipe diameter, with stable appearance and atmospheric shape.
- Trajectory: the smooth trajectory is more in line with the principles of biomechanics and ergonomics. Guard board: the whole front guard board of the small door is made of acrylic plastic, and the back guard board is made of Q235 national standard coldrolled sheet. Cushion: excellent 3D polyurethane molding process; the surface is made of super fiber leather, waterproof and wearresistant; the color can be matched at will.
- Handle: it is made of PVC soft rubber, which is more comfortable to grip.
- Wire wheel: it is made of high quality PA material and injected with national standard high quality bearing, quiet, smooth and fatigue resistant.
- Steel cable: high quality wearresistant special steel wire rope, 6mm in diameter, wrapped with PU wearresistant layer, 7 \* 19 high quality steel wire.

Prone Leg Curl

Size: L1635 W1130 H1536mm N.W.: 265kgs

Training position: biceps femoris



Product name	Pearl Delt /Pec Fly	Model No.	AN38
--------------	---------------------	-----------	------

Picture



Technical description

- Main frame: it is welded with 60 \* 120 \* t3mm positive elliptical pipe diameter, with stable appearance and atmospheric shape.
- Trajectory: the smooth trajectory is more in line with the principles of biomechanics and ergonomics. Guard board: the whole front guard board of the small door is made of acrylic plastic, and the back guard board is made of Q235 national standard coldrolled sheet. Cushion: excellent 3D polyurethane molding process; the surface is made of super fiber leather, waterproof and wearresistant; the color can be matched at will.
- Handle: it is made of P P soft rubber for more comfortable grip.
- Wire wheel: it is made of high quality PA material and injected with national standard high quality bearing, quiet, smooth and fatigue resistant.
- Steel cable: high quality wearresistant special steel wire rope, 6mm in diameter, wrapped with PU wearresistant layer, 7 \* 19 high quality steel wire.

Rear Delt/Pec Fly

Size: L2120 W1345 H1560mm N.W.: 340kgs

Training position: pectoralis major, latissimus dorsi, triceps and biceps

Product name	Incline Chest Press	Model No.	AN47
--------------	---------------------	-----------	------

Picture



Technical description

- Main frame: it is welded with 60 \* 120 \* t3mm positive elliptical pipe diameter, with stable appearance and atmospheric shape.
- Trajectory: the smooth trajectory is more in line with the principles of biomechanics and ergonomics. Guard board: the whole front guard board of the small door is made of acrylic plastic, and the back guard board is made of Q235 national standard coldrolled sheet. Cushion: excellent 3D polyurethane molding process; the surface is made of super fiber leather, waterproof and wear-resistant; the color can be matched at will.
- Handle: PVC soft rubber material, more comfortable grip.
- Wire wheel: it is made of high quality PA material and injected with national standard high quality bearing, quiet, smooth and fatigue resistant.
- Steel cable: high quality wear-resistant special steel wire rope, 6mm in diameter, wrapped with PU wear-resistant layer, 7 \* 19 high quality steel wire.

Incline Chest Press 坐式上斜推胸训练器  
 Size: L1360 W1610 H1520mm N.W.: 220kgs  
 Training position: chest, trapezius, triceps

Product name	Standing Calf	Model No.	AN48
--------------	---------------	-----------	------

Picture



Technical description

- Main frame: it is welded with 60 \* 120 \* t3mm positive elliptical pipe diameter, with stable appearance and atmospheric shape.
- Trajectory: the smooth trajectory is more in line with the principles of biomechanics and ergonomics. Guard board: the whole front guard board of the small door is made of acrylic plastic, and the back guard board is made of Q235 national standard coldrolled sheet. Cushion: excellent 3D polyurethane molding process; the surface is made of super fiber leather, waterproof and wearresistant; the color can be matched at will.
- Handle: PVC soft rubber material, more comfortable grip.
- Wire wheel: it is made of high quality PA material and injected with national standard high quality bearing, quiet, smooth and fatigue resistant.
- Steel cable: high quality wearresistant special steel wire rope, 6mm in diameter, wrapped with PU wearresistant layer, 7 \* 19 high quality steel wire.

Standing Calf Size: L1350 W1130 H1930mm N.W.: 220kgs  
 Training position: calf muscle group

Product name	Triceps Dip	Model No.	AN49
--------------	-------------	-----------	------

Picture



Technical description

- Main frame: it is welded with 60 \* 120 \* t3mm positive elliptical pipe diameter, with stable appearance and atmospheric shape.
- Trajectory: the smooth trajectory is more in line with the principles of biomechanics and ergonomics. Guard board: the whole front guard board of the small door is made of acrylic plastic, and the back guard board is made of Q235 national standard coldrolled sheet. Cushion: excellent 3D polyurethane molding process; the surface is made of super fiber leather, waterproof and wearresistant; the color can be matched at will.
- Handle: PVC soft rubber material, more comfortable grip.
- Wire wheel: it is made of high quality PA material and injected with national standard high quality bearing, quiet, smooth and fatigue resistant.
- Steel cable: high quality wearresistant special steel wire rope, 6mm in diameter, wrapped with PU wearresistant layer, 7 \* 19 high quality steel wire.

Prone Leg Curl Size: L1200 W1100 H1520mm N.W.: 219kgs  
 Training position: triceps pectoralis major, anterior serratus deltoid

Product name	Seated Calf Raise	Model No.	AN53
--------------	-------------------	-----------	------

Picture



Technical description

- Main frame: it is welded with 60 \* 120 \* t3mm positive elliptical pipe diameter, with stable appearance and atmospheric shape.
- Trajectory: the smooth trajectory is more in line with the principles of biomechanics and ergonomics. Guard board: the whole front guard board of the small door is made of acrylic plastic, and the back guard board is made of Q235 national standard coldrolled sheet. Cushion: excellent 3D polyurethane molding process; the surface is made of super fiber leather, waterproof and wearresistant; the color can be matched at will.
- Handle: PVC soft rubber material, more comfortable grip.
- Wire wheel: it is made of high quality PA material and injected with national standard high quality bearing, quiet, smooth and fatigue resistant.
- Steel cable: high quality wearresistant special steel wire rope, 6mm in diameter, wrapped with PU wearresistant layer, 7 \* 19 high quality steel wire.

**Seated Calf Raise**

Size: L1360 W1000 H1500mm N.W.: 265kgs

Training position: calf muscle group

Product name	Muti Functional Trainer	Model No.	AN54
--------------	-------------------------	-----------	------

Picture



Technical description

- Technology: the product appearance design absorbs the foreign advanced design concept, improves on the original basis, more in line with the fitness needs of Chinese people.
- Main frame: the oval tube of 60 \* 120 \* t3mm is used as the tube, which highlights elegance and fashion. The thickness of the main tube is 2.5mm.
- Weight piece: the counterweight adopts strong magnetic bolt, which makes the adjustment in motion more convenient and safe.
- Wire wheel: it is made of high quality PA material and injected with national standard high quality bearing, quiet, smooth and fatigue resistant.
- Steel cable: high quality wearresistant special steel wire rope, 6mm in diameter, wrapped with PU wearresistant layer, 7 \* 19 high quality steel wire.

MutiFunction Trainer/FTS Glide Size: L2020 W1280 H2415mm

N.W.: 350kgs

Training position: pectoralis major muscles, chest muscles, back muscles, arm muscles

Product name	Standing Rear Delt	Model No.	AN74
--------------	--------------------	-----------	------

Picture



Technical description

- Main frame: it is welded with 60 \* 120 \* t3mm positive elliptical pipe diameter, with stable appearance and atmospheric shape.
- Trajectory: the smooth trajectory is more in line with the principles of biomechanics and ergonomics. Guard board: the whole front guard board of the small door is made of acrylic plastic, and the back guard board is made of Q235 national standard coldrolled sheet. Handle: PP soft rubber material, more comfortable to grip.
- Wire wheel: it is made of high quality PA material and injected with national standard high quality bearing, quiet, smooth and fatigue resistant.
- Steel cable: high quality wearresistant special steel wire rope, 6mm in diameter, wrapped with PU wearresistant layer, 7 \* 19 high quality steel wire.

Standing Rear Delt    Size: L1205    W902    H1854mm    N.W.: 243kgs  
 Training position: deltoid muscle group

Product name	Plate Tree	Model No.	AN01
--------------	------------	-----------	------

Picture



Technical description

- Technology: the product production adopts international highend production technology laser cutting, automatic manipulator welding, various CNC bending machine tools and other production equipment to achieve cuttingedge standard tooling.
- Main frame: it is welded with 60 \* 120 \* t3mm positive elliptical pipe diameter, with stable appearance and atmospheric shape.
- Storage: large storage space, can store 7 sets of barbell chips at the same time.
- bell bar: made of highquality PA material, onetime injection molding, with higher strength.。

Plate Tree Size: L880 W760 H970mm N.W.: 31kgs

Product name	Dumbbell Rack	Model No.	AN02
--------------	---------------	-----------	------

Picture





Technical description

- Technology: international highend production technology laser cutting, automatic manipulator welding, various CNC bending machine tools and other production equipment to achieve cuttingedge standard tooling operation.
- Main frame: it is welded with 60 \* 120 \* t3mm positive elliptical pipe diameter, with stable appearance and atmospheric shape.
- Dumbbell bracket: it is made of highquality PA material by onetime injection molding.
- Storage: reasonable storage space, can store ten pairs of dumbbells at the same time.

Dumbbell Rack

Size: L2420 W530 H850mm N.W.: 61kgs

Product name

Barbell Rack for 10pcs

Model No.

AN61

Picture



Technical description

- Technology: international highend production technology laser cutting, automatic manipulator welding, various CNC bending machine tools and other production equipment to achieve cuttingedge standard tooling operation.
- Main frame: it is welded with 60 \* 120 \* t3mm positive elliptical pipe diameter, with stable appearance and atmospheric shape.
- Storage: reasonable storage space, can store ten barbells at the same time.
- Spraying: rust process and electrostatic spraying process complement each other, and three times spraying process is specially adopted.

Barbell Rack

Size: L1055 W870 H1500mm N.W.: 65kgs

Product name

Squat Rack

Model No.

AN50

Picture



Technical description

- Technology: international highend production technology laser cutting, automatic manipulator welding, various CNC bending machine tools and other production equipment to achieve cuttingedge standard tooling operation.
- Main frame: it is welded with 60 \* 120 \* t3mm positive elliptical pipe diameter, with stable appearance and atmospheric shape.
- Storage: large storage space, can store 8 sets of barbell chips at the same time.
- Bell slice bar: made of high quality PA material, onetime injection molding, higher strength

Squat Rack

Size: L1680 W1530 H1820mm N.W.: 150kgs

Product name

Barbell Rack

Model No.

AN03

Picture



Technical description

- Technology: international highend production technology laser cutting, automatic manipulator welding, various CNC bending machine tools and other production equipment to achieve cuttingedge standard tooling operation.
- Main frame: it is welded with 60 \* 120 \* t3mm positive elliptical pipe diameter, with stable appearance and atmospheric shape.
- Storage: reasonable storage space can store five barbell bars at the same time.
- Spraying: rust process and electrostatic spraying process complement each other, especially three times spraying process。

Barbell Rack Size: L940 W640 H1280mm N.W.: 90kgs

Product name	Smith machine	Model No.	AN17
--------------	---------------	-----------	------

Picture



Technical description

- Main frame: it is welded with 60 \* 120 \* t3mm positive elliptical pipe diameter, with stable appearance and atmospheric shape.
- Trajectory: the smooth trajectory is more in line with the principles of biomechanics and ergonomics.
- Wire wheel: it is made of high quality PA material and injected with national standard high quality bearing, quiet, smooth and fatigue resistant.
  - Steel cable: high quality wearresistant special steel wire rope, 6mm in diameter, wrapped with PU wearresistant layer, 7 \* 19 high quality steel wire.
  - Bearing: national standard silent linear bearing, more smooth movement.
  - Aogan: professional customized aogan, meet the needs of different users, choose stainless steel material, use longer.

Smith Machine

Size: L2100 W1400 H2490mm N.W.: 250kgs

Product name	Vertical Bench	Model No.	AN28
--------------	----------------	-----------	------

Picture



Technical description

- Main frame: it is welded with 60 \* 120 \* t3mm positive elliptical pipe diameter, with stable appearance and atmospheric shape.
- Cushion: excellent 3D polyurethane molding process; the surface is made of super fiber leather, waterproof and wearresistant; the color can be matched at will.
- Storage: large storage space, can store 8 sets of barbell chips at the same time.
- Humanized configuration: the humanized adjustable seat structure can adjust the height according to the individual's height,Aogan shelf is available in two gears, with steel framework injected inside, which can better protect the safety of users.

Vertical Bench Size: L1120 W1320 H1870mm N.W.: 74kgs

Product name	Olympic Decline Bench	Model No.	AN44
--------------	-----------------------	-----------	------

Picture



Technical description

- Technology: international highend production technology laser cutting, automatic manipulator welding, various CNC bending machine tools and other production equipment to achieve cuttingedge standard tooling operation.
- Main frame: it is welded with 60 \* 120 \* t3mm positive elliptical pipe diameter, with stable appearance and atmospheric shape.
- Cushion: excellent 3D polyurethane molding process; the surface is made of super fiber leather, waterproof and wearresistant; the color can be matched at will.
- Humanized configuration: humanized adjustable leg foam face, which can be adjusted according to the height of the individual,

Olympic Decline Bench

Size: L2140 W1600 H1360mm N.W.: 50kgs

Product name

Olympic Flat Bench

Model No.

AN52

Picture



Technical description

- Technology: international highend production technology laser cutting, automatic manipulator welding, various CNC bending machine tools and other production equipment to achieve cuttingedge standard tooling operation.
- Main frame: it is welded with 60 \* 120 \* t3mm positive elliptical pipe diameter, with stable appearance and atmospheric shape.
- Cushion: excellent 3D polyurethane molding process; the surface is made of super fiber leather, waterproof and wearresistant; the color can be matched at will.
- The userfriendly configuration: two levels of the pole rack can be selected, and the steel framework is injected inside to better protect the safety of users.

Olympic Flat Bench

Size: L1330 W1860 H1300mm N.W.: 54kgs

Product name

Luxurious Lncline Bench

Model No.

AN59



Picture



Technical description

- Technology: international highend production technology laser cutting, automatic manipulator welding, various CNC bending machine tools and other production equipment to achieve cuttingedge standard tooling operation.
- Main frame: it is welded with 60 \* 120 \* t3mm positive elliptical pipe diameter, with stable appearance and atmospheric shape.
- Cushion: excellent 3D polyurethane molding process; the surface is made of super fiber leather, waterproof and wearresistant; the color can be matched at will.
- Humanized configuration: humanized adjustable seat structure, which can adjust the height according to the height of the individual. Two gears of Austrian pole shelf can be selected, with steel framework injected inside, to better protect the safety of the user.

Luxurious Lncline Bench

Size: L2100 W1300 H1520mm N.W.: 45kgs

Product name

牧师椅

Model No.

AN13

Picture



Technical description

- Technology: international highend production technology laser cutting, automatic manipulator welding, various CNC bending machine tools and other production equipment to achieve cuttingedge standard tooling operation.
- Main frame: it is welded with 60 \* 120 \* t3mm positive elliptical pipe diameter, with stable appearance and atmospheric shape.
- Cushion: excellent 3D polyurethane molding process; the surface is made of super fiber leather, waterproof and wearresistant; the color can be matched at will.
- Humanized configuration: the humanized adjustable seat structure can adjust the height suitable for oneself according to the individual's height.

Scott Bench

Size: L1030 W770 H950mm N.W.: 55kgs

Product name

Roman Chair

Model No.

AN31

Picture



Technical description

- Technology: international highend production technology laser cutting, automatic manipulator welding, various CNC bending machine tools and other production equipment to achieve cuttingedge standard tooling operation.
- Main frame: it is welded with 60 \* 120 \* t3mm positive elliptical pipe diameter, with stable appearance and atmospheric shape.
- Cushion: excellent 3D polyurethane molding process; the surface is made of super fiber leather, waterproof and wearresistant; the color can be matched at will.
- Handle: PVC soft rubber material, more comfortable grip.
- Humanized configuration: the humanized adjustable seat structure can adjust the height suitable for oneself according to the individual's height.

Roman Chair

Size: L1240 W670 H850mm N.W.: 22kgs

Product name

Utility Bench

Model No.

AN40

Picture



Technical description

- Technology: international highend production technology laser cutting, automatic manipulator welding, various CNC bending machine tools and other production equipment to achieve cuttingedge standard tooling operation.
- Main frame: it is welded with 60 \* 120 \* t3mm positive elliptical pipe diameter, with stable appearance and atmospheric shape.
- Cushion: excellent 3D polyurethane molding process; the surface is made of super fiber leather, waterproof and wearresistant; the color can be matched at will.

Utility Bench

Size: L1050 W660 H920mm N.W.: 30kgs

Product name

Web Board

Model No.

AN57

Picture



Technical description

- Technology: international highend production technology laser cutting, automatic manipulator welding, various CNC bending machine tools and other production equipment to achieve cuttingedge standard tooling operation.
- Main frame: it is welded with 60 \* 120 \* t3mm positive elliptical pipe diameter, with stable appearance and atmospheric shape.
- Cushion: excellent 3D polyurethane molding process; the surface is made of super fiber leather, waterproof and wearresistant; the color can be matched at will.

Web Board

Size: L1860 W650 H950mm N.W.: 40kgs

Product name	三层哑铃架	Model No.	AN72
--------------	-------	-----------	------

Picture

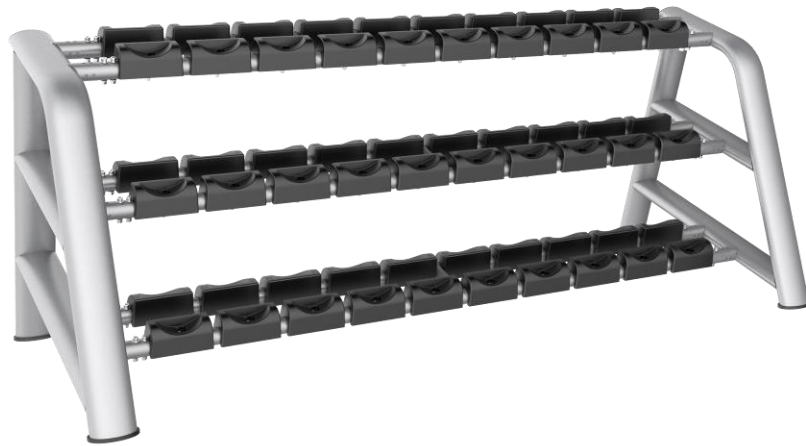

Technical description

- Technology: international highend production technology laser cutting, automatic manipulator welding, various CNC bending machine tools and other production equipment to achieve cuttingedge standard tooling operation.
- Main frame: it is welded with 60 \* 120 \* t3mm positive elliptical pipe diameter, with stable appearance and atmospheric shape.
- Dumbbell holder: it is made of high quality PA material, and it is injected once.
- Storage: reasonable storage space, can store 15 pairs of dumbbells at the same time

Three Rows Dumbbell Rack

Size: L2450 W950 H970mm N.W.: 85kgs

Product name	可调式腹肌训练椅	Model No.	AN07
--------------	----------	-----------	------

Picture



Technical description

- Technology: international highend production technology laser cutting, automatic manipulator welding, various CNC bending machine tools and other production equipment to achieve cuttingedge standard tooling operation.
- Main frame: it is welded with 60 \* 120 \* t3mm positive elliptical pipe diameter, with stable appearance and atmospheric shape.
- Cushion: excellent 3D polyurethane molding process; the surface is made of super fiber leather, waterproof and wearresistant; the color can be matched at will.
- Humanized configuration: the humanized adjustable leg pad structure can adjust the height according to the height of the individual; the angle of the back pad can be adjusted to better exercise each muscle of the abdomen.

Crunch Bench

Size: L1440 W640 H850mm N.W.: 45kgs



Product name	Flat bench	Model No.	AN08
--------------	------------	-----------	------

Picture



Technical description

- Technology: international highend production technology laser cutting, automatic manipulator welding, various CNC bending machine tools and other production equipment to achieve cuttingedge standard tooling operation.
- Main frame: it is welded with 60 \* 120 \* t3mm positive elliptical pipe diameter, with stable appearance and atmospheric shape.
- Cushion: excellent 3D polyurethane molding process; the surface is made of super fiber leather, waterproof and wearresistant; the color can be matched at will.

Flat Bench Size: L1240 W700 H530mm N.W.: 35kgs

Product name	Adjustable Bench	Model No.	AN12
--------------	------------------	-----------	------

Picture



Technical description

- Technology: international highend production technology laser cutting, automatic manipulator welding, various CNC bending machine tools and other production equipment to achieve cuttingedge standard tooling operation.
- Main frame: it is welded with 60 \* 120 \* t3mm positive elliptical pipe diameter, with stable appearance and atmospheric shape.
- Cushion: excellent 3D polyurethane molding process; the surface is made of super fiber leather, waterproof and wearresistant; the color can be matched at will.
- Humanized configuration: humanized adjustable cushion and back cushion structure can better cooperate with users to exercise different muscles。

Adjustable Bench Size: L1190 W690 H1300mm N.W.: 35kgs

Product name	顺蹬机	Model No.	AN55
--------------	-----	-----------	------

Picture



Technical description

- Technology: international highend production technology laser cutting, automatic manipulator welding, various CNC bending machine tools and other production equipment to achieve cuttingedge standard tooling operation.
- Main frame: it is welded with 60 \* 120 \* t3mm positive elliptical pipe diameter, with stable appearance and atmospheric shape.
- Trajectory: the smooth trajectory is more in line with the principles of biomechanics and ergonomics.Cushion: excellent 3D polyurethane molding process; the surface is made of super fiber leather, waterproof and wearresistant; the color can be matched at will.
- Handle: PP soft rubber material, more comfortable to grip.
- Guide wheel: it is made of highquality PA material and injected with national standard highquality bearing, quiet, smooth and fatigue resistant.

Hack Squat Size: L2100 W1660 H1290mm N.W.:300kgs

Training position: biceps femoris, quadriceps femoris, gluteus maximus, etc

Product name	可调节罗马椅	Model No.	AN73
--------------	--------	-----------	------

Picture



Tec  
hni  
cal  
des  
crip  
tion

- Technology: international highend production technology laser cutting, automatic manipulator welding, various CNC bending machine tools and other production equipment to achieve cuttingedge standard tooling operation.
- Main frame: it is welded with 60 \* 120 \* t3mm positive elliptical pipe diameter, with stable appearance and atmospheric shape.
- Cushion: excellent 3D polyurethane molding process; the surface is made of super fiber leather, waterproof and wearresistant; the color can be matched at will.
- Handle: PVC soft rubber material, more comfortable grip.
- Humanized configuration: humanized adjustable large frame structure can better cooperate with users to exercise different muscles.

Adjustable Roman Chaic

Size: L1350 W680 H880mm N.W.: 50kgs

Product name	Leg Press	Model No.	AN56
--------------	-----------	-----------	------

Picture



Technical description

- Main frame: it is welded with 60 \* 120 \* t3mm positive elliptical pipe diameter, with stable appearance and atmospheric shape.
- Trajectory: the smooth trajectory is more in line with the principles of biomechanics and ergonomics. Cushion: excellent 3D polyurethane molding process; the surface is made of super fiber leather, waterproof and wearresistant; the color can be matched at will.
- Handle: PP soft rubber material, more comfortable to grip.
- Guide wheel: it is made of highquality PA material and injected with national standard highquality bearing, quiet, smooth and fatigue resistant.

Leg Press Size: L2330 W1470 H1775mm N.W.: 230kgs

Training position: biceps femoris, quadriceps femoris, gluteus maximus, etc

Product name	Vertical Knees Up Dip	Model No.	AN58
--------------	-----------------------	-----------	------

Picture



Tec  
hni  
cal  
des  
crip  
tion

- Technology: international highend production technology laser cutting, automatic manipulator welding, various CNC bending machine tools and other production equipment to achieve cuttingedge standard tooling operation.
- Main frame: it is welded with 60 \* 120 \* t3mm positive elliptical pipe diameter, with stable appearance and atmospheric shape.
- Cushion: 3D polyurethane molding process with excellent texture; the surface is made of super fiber leather, waterproof and wearresistant; the color can be matched at will.
- Handle: PP soft rubber material, more comfortable to grip.

Vertical Knees Up Dip Size: L1350 W840 H1800mm N.W.: 55kgs  
Training site: abdominal muscle group

Product name

Hip Machines

Model No.

AN65

Picture

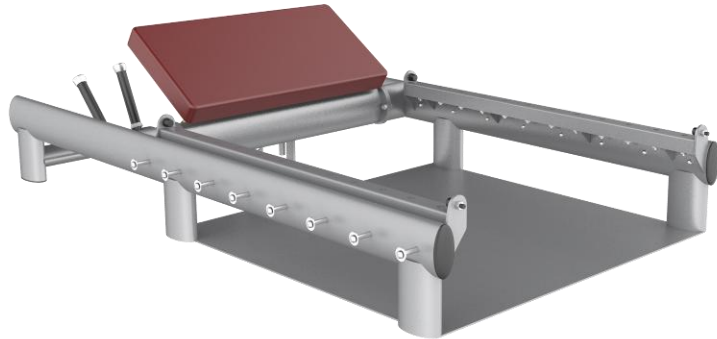

Tec  
hni  
cal  
des  
crip  
tion

- Technology: international highend production technology laser cutting, automatic manipulator welding, various CNC bending machine tools and other production equipment to achieve cuttingedge standard tooling operation.
- Main frame: it is welded with 60 \* 120 \* t3mm positive elliptical pipe diameter, with stable appearance and atmospheric shape.
- Cushion: excellent 3D polyurethane molding process; the surface is made of super fiber leather, waterproof and wearresistant; the color can be matched at will.
- Handle: PP soft rubber material, more comfortable to grip.
- Humanized configuration: humanized adjustable cushion structure, adjustable height and angle; it can better cooperate with users to exercise different muscles.

Hip Machines

Size: L1930 W1190 H420mm N.W.: 130kgs

Product name	T incline Rower Machine	Model No.	AN70
--------------	-------------------------	-----------	------

Picture



Tec  
hni  
cal  
des  
crip  
tion

- Technology: international highend production technology laser cutting, automatic manipulator welding, various CNC bending machine tools and other production equipment to achieve cuttingedge standard tooling operation.
- Main frame: it is welded with 60 \* 120 \* t3mm positive elliptical pipe diameter, with stable appearance and atmospheric shape.
- Handle: PP soft rubber material, more comfortable to grip.
- Paint baking: sand blasting and electrostatic powder spraying are complementary to each other. Three times of spraying and 180 ° hightemperature baking are adopted to melt the powder coating, which can be well adhered to the surface of parts.

T incline Rower Machine Size: L2170 W800 H500mm N.W.: 58kgs

Product name

Knee Up/Chin+Pull  
Up

Model No.

AN75

Picture





Tec  
hni  
cal  
des  
crip  
tion

- Technology: international highend production technology laser cutting, automatic manipulator welding, various CNC bending machine tools and other production equipment to achieve cuttingedge standard tooling operation.
  - Main frame: it is welded with 60 \* 120 \* t3mm positive elliptical pipe diameter, with stable appearance and atmospheric shape.
  - Cushion: excellent 3D polyurethane molding process; the surface is made of super fiber leather, waterproof and wearresistant; the color can be matched at will.
  - Handle: PP soft rubber material, more comfortable to grip.
- Paint baking: sand blasting and electrostatic powder spraying are complementary to each other. Three times of spraying and 180 ° hightemperature baking are adopted to melt the powder coating, which can be well adhered to the surface of parts.

Knee Up/Chin+Pull Up

Size: L1458 W1360 H2240mm N.W.: 208kgs

Product name	Cable Jungle	Model No.	AN43
Picture			



Tec  
hni  
cal  
des  
crip  
tion

- Technology: international highend production technology laser cutting, automatic manipulator welding, various CNC bending machine tools and other production equipment to achieve cuttingedge standard tooling operation.
- Main frame: it is welded with 60 \* 120 \* t3mm positive elliptical pipe diameter, with stable appearance and atmospheric shape.
- Trajectory: the smooth trajectory is more in line with the principles of biomechanics and ergonomics.Cushion: excellent 3D polyurethane molding process; the surface is made of super fiber leather, waterproof and wearresistant; the color can be matched at will.
- Handle: PP soft rubber material, more comfortable to grip.
- Wire wheel: it is made of high quality PA material and injected with national standard high quality bearing, quiet, smooth and fatigue resistant.
- Steel cable: high quality wearresistant special steel wire rope, 6mm in diameter, wrapped with PU wearresistant layer, 7 \* 19 high quality steel wire.

Cable Jungle

Size: L1790 W1620 H2250mm N.W.: 510kgs

Product name	Cable Crossover	Model No.	AN14
Picture			

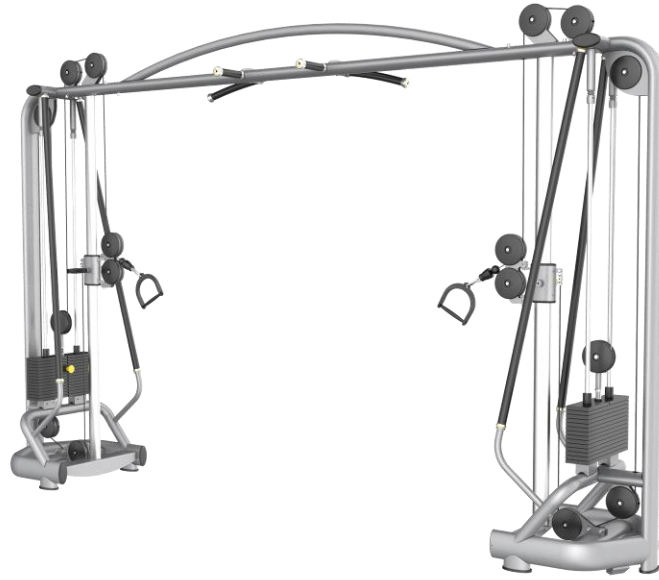

Technical description

- Technology: international highend production technology laser cutting, automatic manipulator welding, various CNC bending machine tools and other production equipment to achieve cuttingedge standard tooling operation.
- Main frame: it is welded with 60 \* 120 \* t3mm positive elliptical pipe diameter, with stable appearance and atmospheric shape.  
Trajectory: the smooth trajectory is more in line with the principles of biomechanics and ergonomics.
- Handle: PP soft rubber material, more comfortable to grip.
- Wire wheel: it is made of high quality PA material and injected with national standard high quality bearing, quiet, smooth and fatigue resistant.
- Steel cable: high quality wearresistant special steel wire rope, 6mm in diameter, wrapped with PU wearresistant layer, 7 \* 19 high quality steel wire.

Cable Crossover

Size: L3820 W680 H2400mm N.W.: 300kgs

Product name	Crossover&Cable Jungle	Model No.	AN41
Picture			

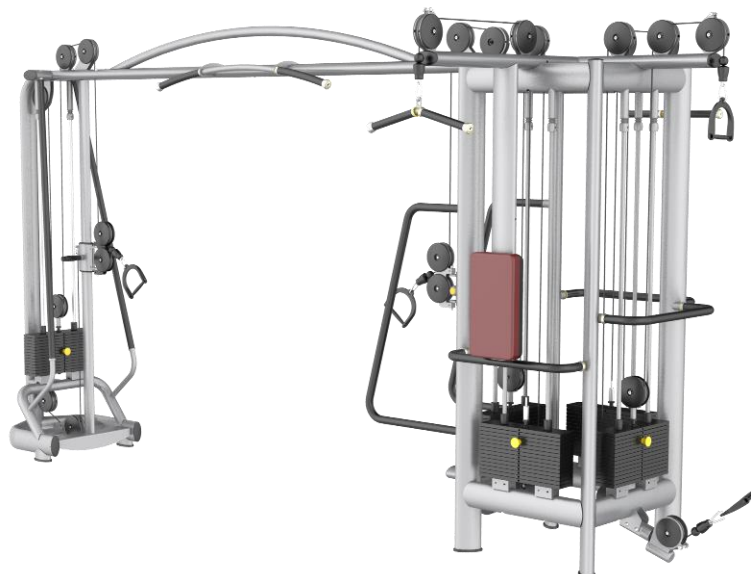

Technical description

- Technology: international highend production technology laser cutting, automatic manipulator welding, various CNC bending machine tools and other production equipment to achieve cuttingedge standard tooling operation.
- Main frame: it is welded with 60 \* 120 \* t3mm positive elliptical pipe diameter, with stable appearance and atmospheric shape.
- Trajectory: the smooth trajectory is more in line with the principles of biomechanics and ergonomics.Cushion: excellent 3D polyurethane molding process; the surface is made of super fiber leather, waterproof and wearresistant; the color can be matched at will.
- Handle: PP soft rubber material, more comfortable to grip.
- Wire wheel: it is made of high quality PA material and injected with national standard high quality bearing, quiet, smooth and fatigue resistant.
- Steel cable: high quality wearresistant special steel wire rope, 6mm in diameter, wrapped with PU wearresistant layer, 7 \* 19 high quality steel wire.

Crossover&Cable Jungle

Size: L4620 W1920 H2680mm N.W.: 680kgs

Product name	Crossover&Cable Jungle	Model No.	AN42
Picture			



Technical description

- Technology: international highend production technology laser cutting, automatic manipulator welding, various CNC bending machine tools and other production equipment to achieve cuttingedge standard tooling operation.
  - Main frame: it is welded with 60 \* 120 \* t3mm positive elliptical pipe diameter, with stable appearance and atmospheric shape.
  - Trajectory: the smooth trajectory is more in line with the principles of biomechanics and ergonomics.Cushion: excellent 3D polyurethane molding process; the surface is made of super fiber leather, waterproof and wearresistant; the color can be matched at will.
- Handle: PP soft rubber material, more comfortable to grip.
- Wire wheel: it is made of high quality PA material and injected with national standard high quality bearing, quiet, smooth and fatigue resistant.
  - Steel cable: high quality wearresistant special steel wire rope, 6mm in diameter, wrapped with PU wearresistant layer, 7 \* 19 high quality steel wire.

Crossover&Cable Jungle

Size: L5550 W2770 H2770mm N.W.: 790kgs

Product name	8 Stations	Model No.	AN60
Picture			

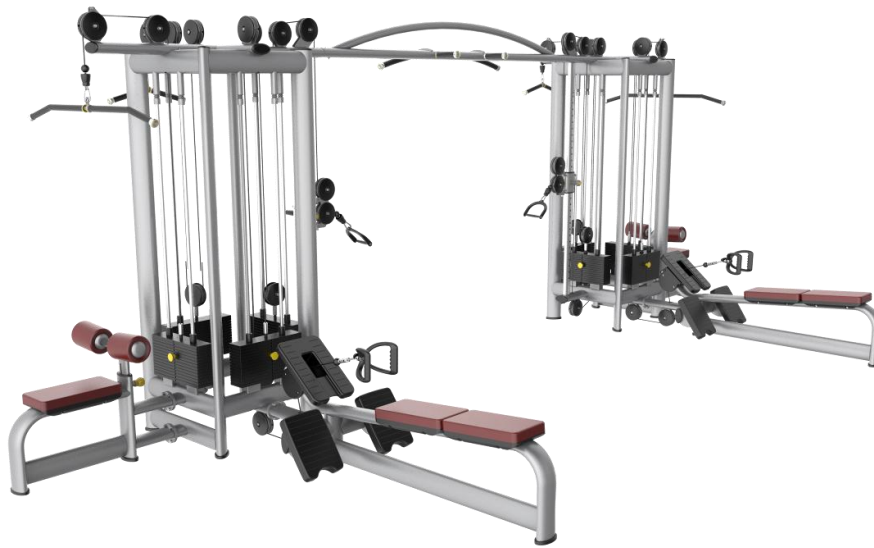

Technical  
description

- Technology: international highend production technology laser cutting, automatic manipulator welding, various CNC bending machine tools and other production equipment to achieve cuttingedge standard tooling operation.
- Main frame: it is welded with 60 \* 120 \* t3mm positive elliptical pipe diameter, with stable appearance and atmospheric shape.
- Trajectory: the smooth trajectory is more in line with the principles of biomechanics and ergonomics.Cushion: excellent 3D polyurethane molding process; the surface is made of super fiber leather, waterproof and wearresistant; the color can be matched at will.
- Handle: PP soft rubber material, more comfortable to grip.
- Wire wheel: it is made of high quality PA material and injected with national standard high quality bearing, quiet, smooth and fatigue resistant.
- Steel cable: high quality wearresistant special steel wire rope, 6mm in diameter, wrapped with PU wearresistant layer, 7 \* 19 high quality steel wire.

8 Stations

Size: L6500 W3460 H2310mm N.W.: 1100kgs